

SCHEMA DI MONTAGGIO :

SERIE REA SCRIVANIA DATILO TAVOLO

RA 100-RA101-RA102-RA103-RA104

RA105-RA106-RA107-RA108

RA116-RA117-RA118-RA119

Sequenza di montaggio numerata

FERRAMENTA:

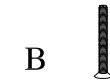

Piano in legno sagomato

Piano in legno sagomato

Piano in legno

Piano in vetro

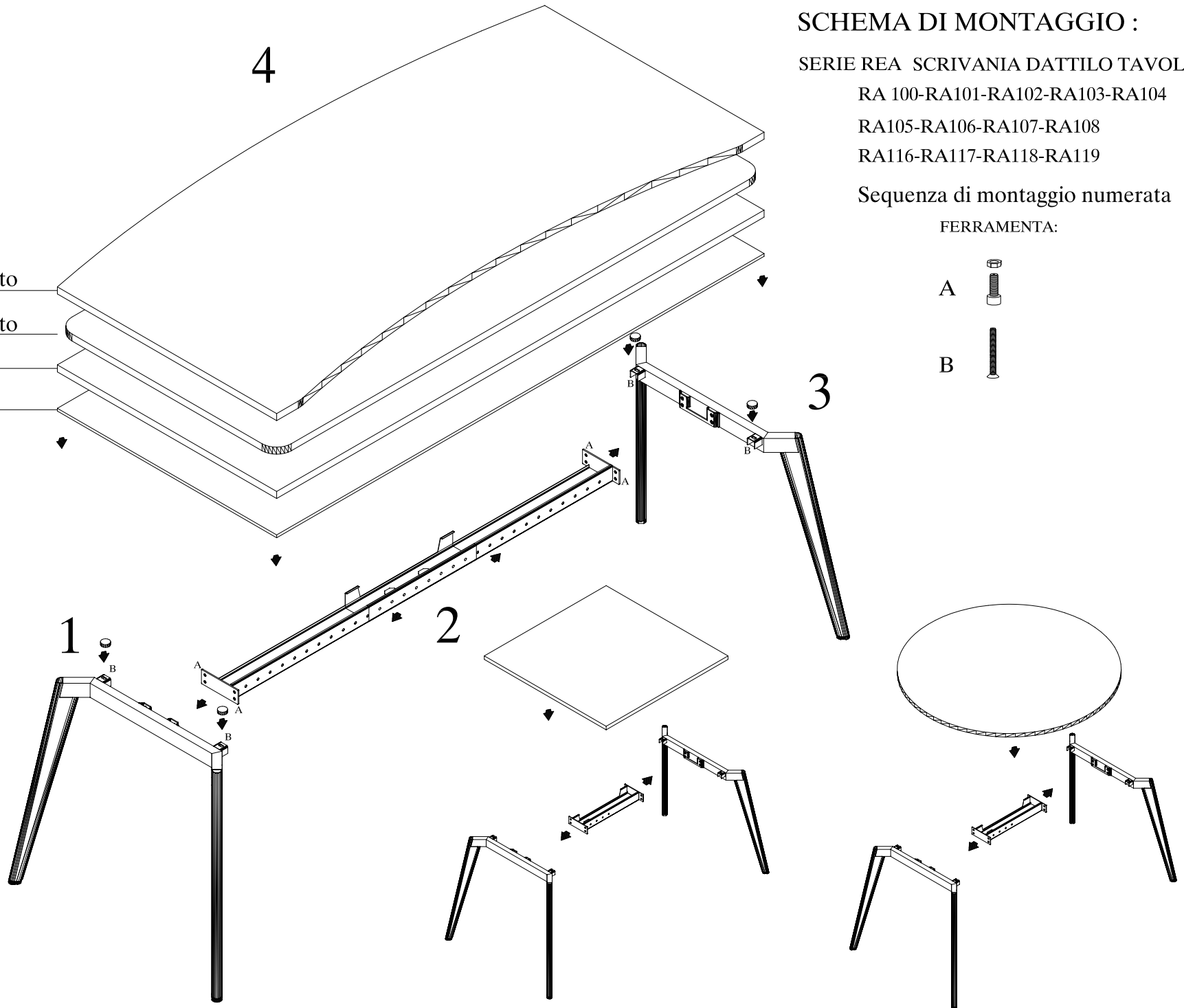





Piano in vetro

SCHEMA DI MONTAGGIO :
SERIE REA DISTANZIALE PER PIANO VETRO
SCRIVANIE RA111-R119



Schema di montaggio
distanziale centrale per piano in vetro

FERRAMENTA:

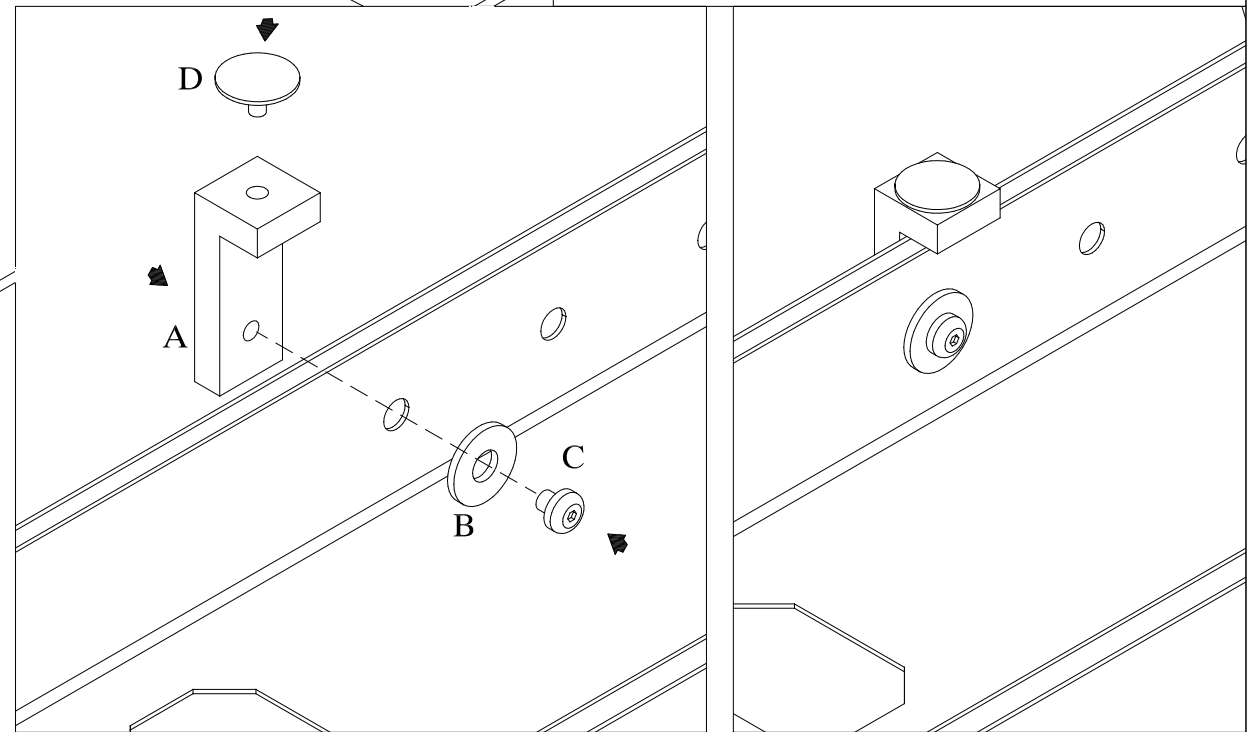
- A  Distanziale piano
- B  Rondella
- C  Vite
- D  Ventosa

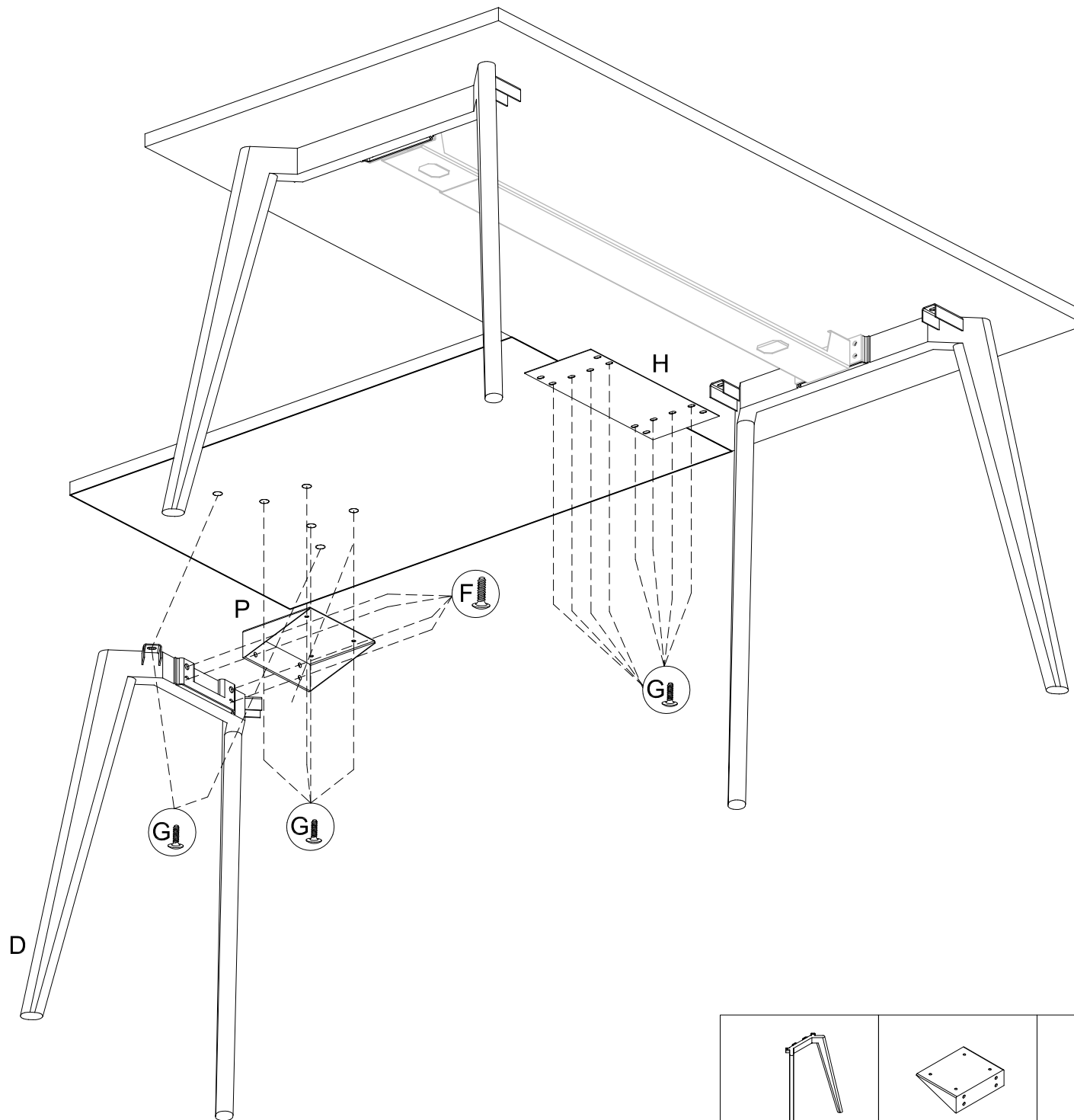

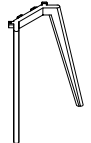
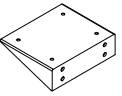

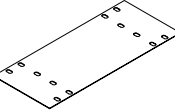
 D x 4	 P x 4	 F x 4	 G x 14	 H x 1
--	--	--	---	--

SCHEMA DI MONTAGGIO :

SERIE REA SCRIVANIE +SERVENTE

RA 109-RA110-RA111-RA112-RA113

RA114-RA115

Sequenza di montaggio numerata

Piano in legno sagomato

Piano in legno sagomato

Piano in legno

Piano in vetro

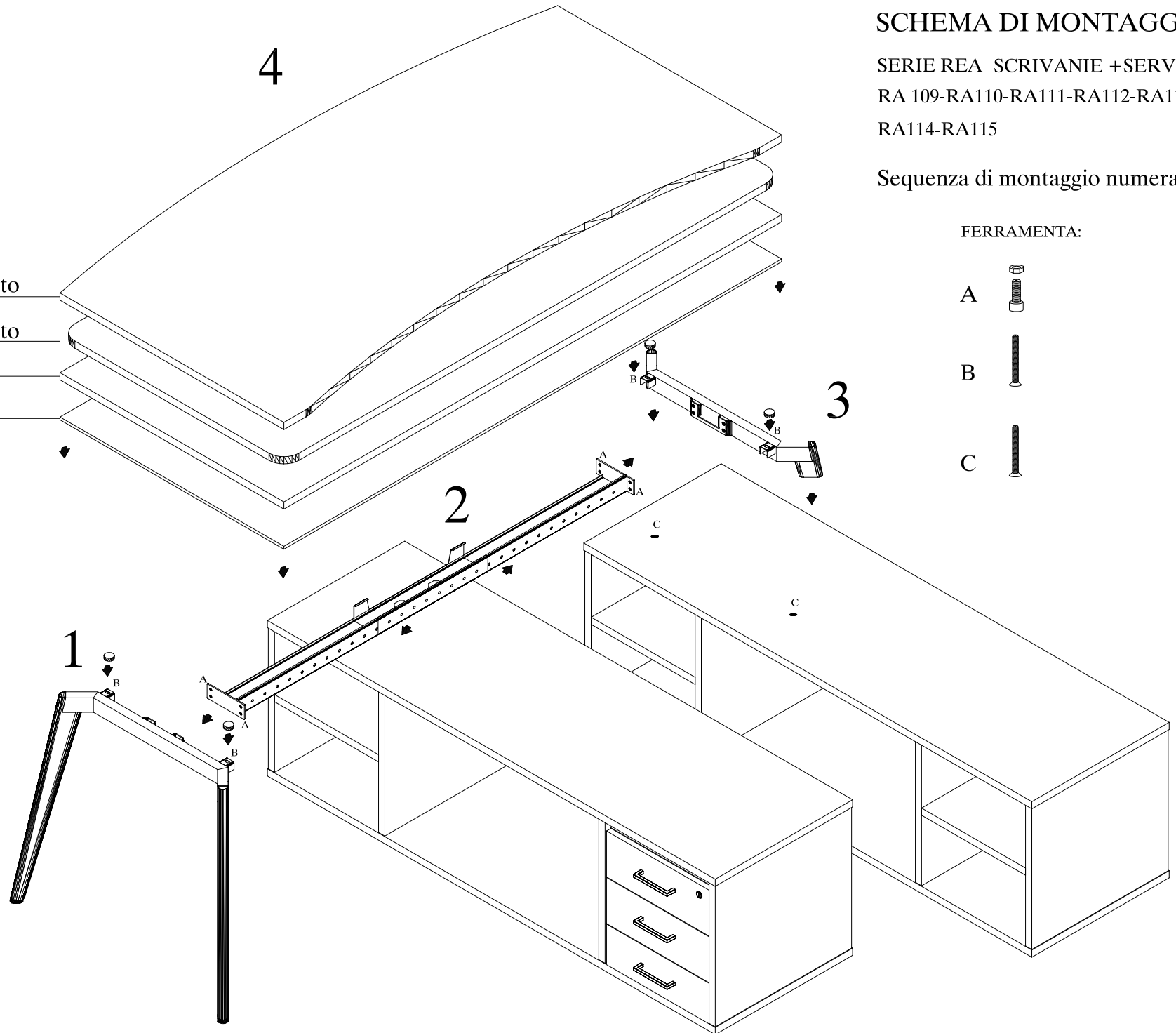

FERRAMENTA:

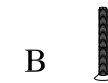

SCHEMA DI MONTAGGIO :
SERIE REA SERVENTE+CASSETTIERA
ST 824-ST 824C

Sequenza di montaggio numerata

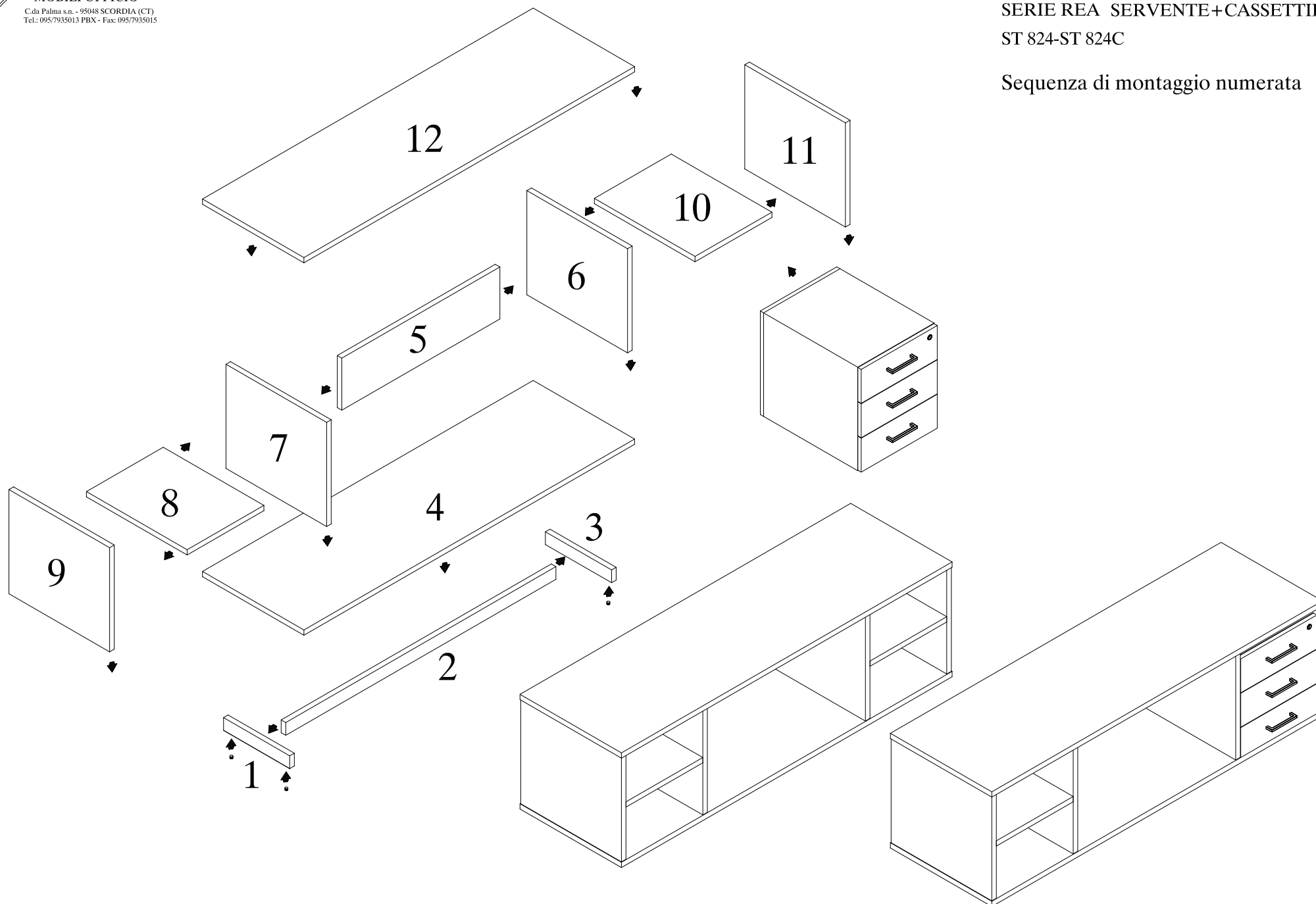

SCHEMA DI MONTAGGIO :

SERIE REA TAVOLI RIUNIONE

RA 127-RA128

Sequenza di montaggio numerata

FERRAMENTA:

